



Selecting an Onsite Wastewater or Septic System

If a site is not served by a central sewer system, some kind of onsite wastewater treatment and dispersal system must be used. A traditional septic tank and lateral field is the most common system. However, there are many alternatives. Some choices are better suited for specific site conditions than others.

To function well, the system needs to accommodate site conditions and the maximum wastewater flow at the present and in the future. When soil and site conditions allow, a septic tank and dispersal field will meet the need. When this is not the case, other options must be considered. This publication identifies and gives information to help select one of the many options.

All systems require maintenance. A traditional septic system needs regular septic tank pumping, sensible water use, and wise choices of what materials are put down the drain. Lagoons require vegetation management and water level control. More extensive maintenance is required for the electrical and mechanical components of alternative systems.

This publication is written for Kansas residents. The information is useful in other states, but some things may not apply. Kansas does not allow surface discharge from onsite systems. Kansas Department of Health and Environment, Bulletin 4-2 specifies a minimum 4 feet of unsaturated, permeable soil beneath a soil dispersal field, except when full treatment is provided. The county code can increase these minimums.

Tips for Owners

The same care and research should be given to selecting, contracting, constructing, and caring for an onsite wastewater system as for any other major purchase. Analysis of the expected current and future needs, as well as regulatory requirements, should be considered. The time and expense required to keep the system operating well, either by a service provider or the owner, is important and must be included.

The soil depth and its properties, plus the size and configuration of the site, often determines the systems best suited for the site. Additional factors that should be considered are:

- location of water supplies and underground utilities;
- operation in extreme conditions: rain, temperature;

- system availability, certification, and warranty;
- experienced and qualified installer/contractor (references, license, training, insurance, etc.);
- life of system, components, and access to repair parts;
- maintenance needs: frequency and amount;
- availability of trained, reliable service provider;
- need for enhanced treatment, like nutrient removal;
- system initial installation cost and annualized payoff;
- power reliability and cost;
- annual cost for operation, maintenance, and repair;
- system compatibility with owner's needs or lifestyle.

Types of Onsite Systems

Anaerobic and aerobic biological treatments, as well as settling of solids, are involved in onsite wastewater systems. In traditional systems, these occur in the septic tank and soil dispersal field respectively. The processes retain solids, break down wastes, stabilize wastewater, and deactivate pathogens. In lagoons, anaerobic processes occur in the lower part of the lagoon, and aerobic processes occur near the surface. Figure 1 illustrates aerobic and anaerobic treatment for various onsite wastewater categories.

When the soil depth is too shallow or permeability (ability to absorb and transmit water) is too slow, a system providing greater wastewater pretreatment may be used. Alternative systems often achieve much of the aerobic treatment that would normally occur in the soil. Thus, they can be added when the soil is shallow or when the area is small to achieve adequate treatment and improve dispersal. With aeration, air is injected to enhance treatment.

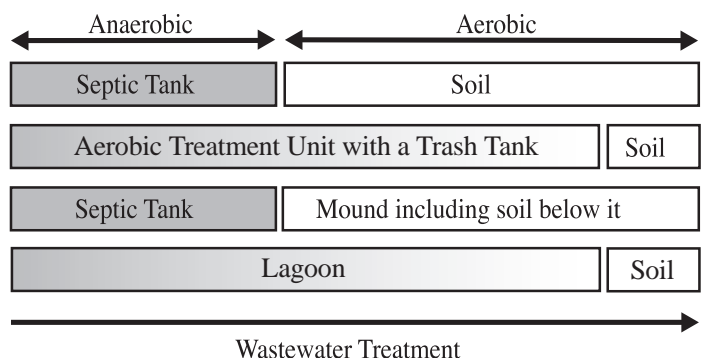

Figure 1. Onsite wastewater treatment systems.

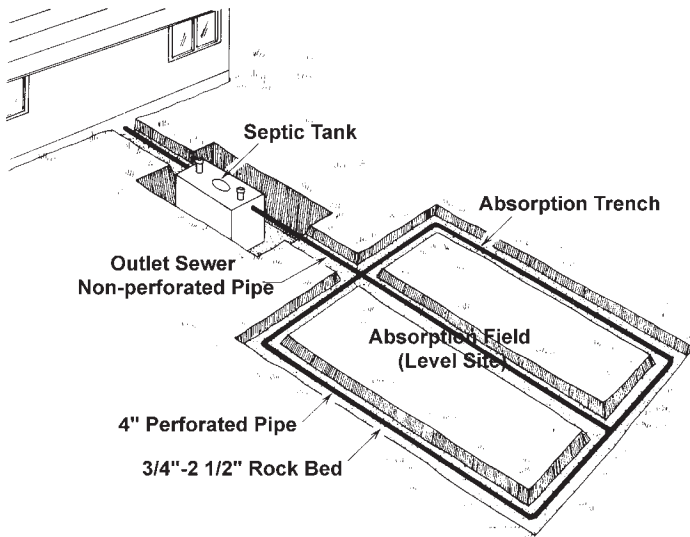

Figure 2. Traditional septic tank – soil dispersal system.

All systems accomplish the same job – the treatment of wastewater — but, the size, cost, and physical appearance can be quite different.

Although some soil-dispersal types are commonly matched with certain alternative systems, this may be more a function of the product lines carried by a distributor than a technical requirement. Septic tanks and most alternative systems can be matched with any of several soil-dispersal designs.

Traditional Onsite Systems

A septic tank and soil dispersal laterals is by far the most common onsite wastewater system used in Kansas (see Figure 2). Wastewater treatment begins in the septic tank, and final treatment and recycle of the effluent occurs in the dispersal field. Maintenance of traditional systems includes regular pumping of the septic tank, typically every three to five years. If the septic tank has an effluent filter, it should be checked at least every six months and cleaned as needed. The dispersal field should be checked regularly for signs of problems, wastewater surfacing, soggy soil, and odor. Limiting the amount of waste and

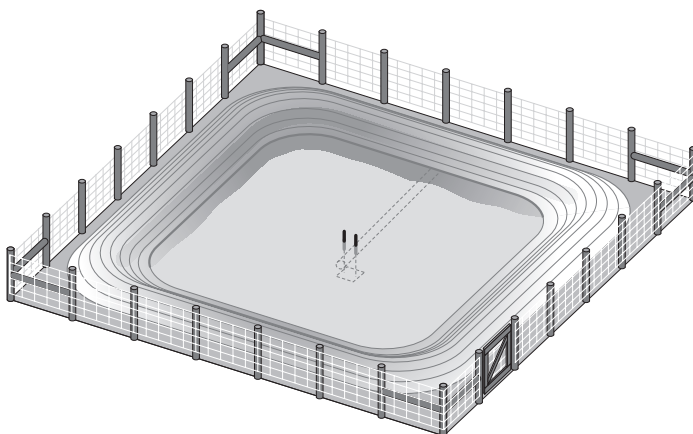

Figure 3. Traditional wastewater stabilization pond or lagoon.

water will improve performance, reduce maintenance, and extend the system's life. For more information on the use of septic systems see *Get to Know Your Septic System*, MF-2179, or *Septic Tank Maintenance*, MF-947.

A wastewater stabilization pond (lagoon) has an optimum operating depth of 3 to 5 feet and is usually constructed 6 to 8 feet deep (see Figure 3). Bacteria and other microbes treat the wastewater. Dispersed, single-cell algae and air movement across the surface supply oxygen to the lagoon's upper layer. A lagoon requires a larger lot size, usually at least 2 acres. For an impermeable, high-clay soil, a lagoon is an inexpensive, effective, and practical option when sufficient area and a suitable site are available. Fencing is essential to keep children and animals, especially pets, away from the wastewater, thus protecting health and safety.

The wastewater level in a lagoon should be monitored and recorded monthly. Additional water should be added to help control plants when the level falls below 3 feet deep. Water conservation is essential or enlargement is needed when the level is within 2 feet of the top and still rising. The grass cover on the berm should be kept short. Plants growing in the water should be removed. Cattails and duckweed are common weed problems that interfere with good operation and therefore must be controlled. For more information on the design and use of lagoons see publications *Wastewater Pond Design and Construction*, MF-2290, and *Wastewater Pond Operation, Maintenance and Repair*, MF-1044.

Alternative (or Enhanced) Treatment Systems

Onsite system components designed to treat septic tank effluent before it goes to the dispersal field are often called alternative treatment systems. They include aerobic treatment units (ATU); various filters (sand, media, and rock-plant); and mounds. All onsite systems require maintenance, but, because of mechanical, electrical, and/or vegetation components, alternative systems require more maintenance. When maintenance is neglected, function, performance, reliability, and life expectancy are reduced.

Factory-built systems, rather than those built onsite, often have manufacturer-trained service providers. Systems certified by NSF International (formerly National Sanitation Foundation) include a two-year maintenance contract with purchase. Because ongoing system maintenance is essential, a contract with a service provider may be required by county code and in any case is strongly recommended for all alternative treatment systems.

When high effluent quality is needed or wanted before dispersal, any alternative treatment system can be used. Some systems offer advantages over others in specific cases. For instance, sand filters and rock-plant filters are better for rocky sites because they are shallow and do not require a deep hole. On sites with limited space, an

aeration system may be the best choice because sand and rock-plant filters require more area.

Alternative treatment can be used to overcome some site and soil limitations, including:

- When the aerated soil profile is less than the minimum 4 feet, an alternative system accomplishes most of the treatment normally done by the soil. This assures adequate treatment before the percolate reaches groundwater.
- In environmentally sensitive areas, an alternative system treats the wastewater to a higher standard and, in some systems, also reduces nitrogen levels.
- If a lateral field fails because of excess biomat (organic and bacterial slime) growth, an alternative system reduces the organic load and may restore infiltration to the dispersal field.
- If the wastewater is high strength, such as that from a restaurant, pretreatment by an alternative system can reduce the concentration so that the soil can handle it.
- An alternative system may make a smaller dispersal field possible, however the reduction is less for clayey soils.
- An alternative system is often required or recommended for drip dispersal.

Sand and Media Filters

A **sand filter** (see Figure 4) is a bed of sand contained in a waterproof liner and placed between the septic tank and soil-dispersal field. Septic tank effluent is pump-dosed onto the sand several times a day. As the effluent trickles through the sand, suspended particles are filtered, and bacteria growing in the bed treat the wastewater. In the intermittent sand filter (ISF), effluent percolates through the bed and discharges to the dispersal field. Recirculating sand filters (RSF) return much of the percolate to the dose chamber where some nitrate removal may occur. Some sand filters are constructed without liners and discharge directly to the soil underneath, similar to a mound.

The sand filter consists of a pump controlled by float switches and timer, alarm, pressure dosing pipes, the sand bed, and drains. Percolate gravity flows or is pumped to a soil-dispersal field. The sand bed — composed of uni-

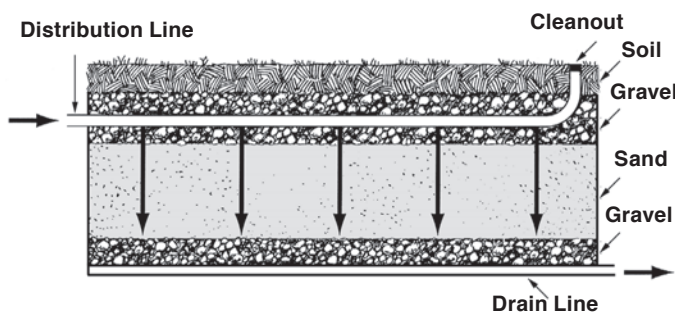

Figure 4. Sand filter.

formly sized medium to coarse grains with no fine sand, silt, or clay particles — is usually 2 feet thick.

In addition to maintenance of the pump and controls, dosing lines must be flushed and the pressure on each line checked at six-month intervals. The lines can be flushed or cleaned with a bottlebrush attached to a plumber's snake. A plugged orifice blocks use of a portion of the filter causing the rest of the filter to receive a higher loading rate. Sand filters covered with soil and grass should be mowed regularly. If a gravel cover is used, vegetation should be pulled and debris removed as needed.

Other media filters. Sand-like particles (including crushed glass, bottom ash, and expanded shale) can be used as filter media. The particles used should approximate the size distribution of sand or be based on research using the specific media. Other materials with large surface areas supporting bacterial growth (including peat, textile, or foam) have been used successfully to treat wastewater. There are both manufactured and site-built systems based on research using these media.

Mound. A mound system consists of a layer of clean, uniformly graded sand on a prepared natural soil surface. A pumped dose system that uniformly applies effluent to a distribution bed on top of the sand (see Figure 5) is essential. A mound is similar to a long, narrow sand filter with no sides or lined bottom. No additional dispersal field is required, because after treatment through the sand, the effluent percolates directly into the soil under the mound.

Topsoil and grass cover the mound and a good site design incorporates the mound into the landscape plan. Mounds are usually limited to slopes of less than 15 percent. Mound designs are site-specific, which increases the time and expense for installation.

After construction, the mound, like all soil dispersal systems, should be protected from traffic and the grass cover should be mowed. The bed should have inspection ports, so wastewater distribution can be checked. Distribution lines should have cleanouts so they can be flushed at least twice a year. Pumps, floats, and alarms must be checked as part of the regular maintenance.

Aerobic Treatment Unit (ATU). When oxygen is supplied, the rate of microbial activity in the wastewa-

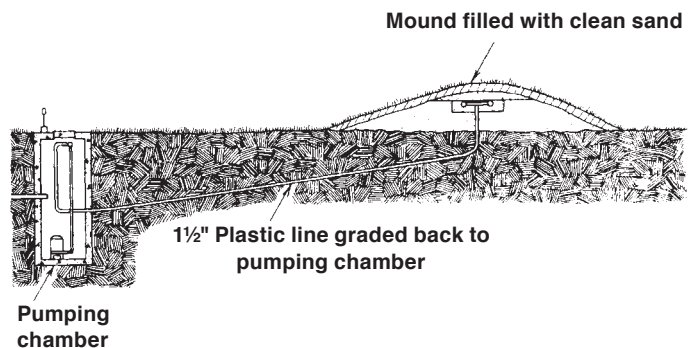

Figure 5. Mound.

ter increases and treatment progresses faster. Oxygen is added by injecting air into the wastewater or by spraying wastewater into the air. Aeration systems are largely preassembled at a factory so installation is relatively simple. The units are transported to a site and connected to the wastewater piping and electricity according to the manufacturer's instructions. There are many designs and manufacturers of aerobic treatment units.

Three processes are involved in most aeration systems: physical separation, aeration, and clarification. These processes may be in separate tanks, compartments of a single tank, or other configurations (see Figure 6). Some aeration units are installed in a septic tank, and others use a separate septic tank or provide their own specialized tank. The tanks or compartments are usually constructed of concrete or fiberglass.

Odors and alarms indicate a need for service. In addition to maintenance of the mechanical and electrical parts including pumps, level switches, timers, blowers, diffusers, and filters, regular pumping of the septic or trash tank is necessary. Other compartments also may require occasional pumping or cleaning. Because care to avoid damage of system components during pumping is essential, it is best to use a pumper who is familiar with these systems.

An ATU system should have local service support and a good warranty. NSF has a certification program for aeration units based on testing over a range of operating conditions. NSF certification requires the manufacturer to provide inspection and service calls for the first 2 years. *Continuation of a similar service contract is strongly recommended, if not already required by local regulations.*

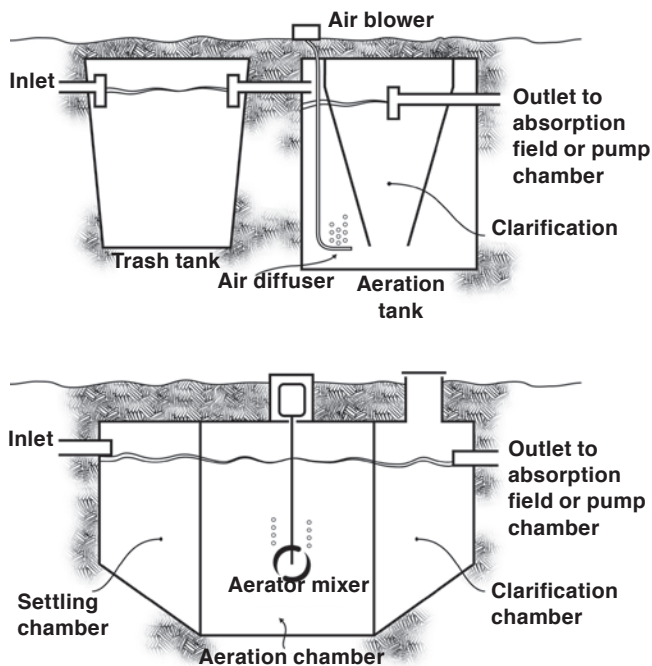

Figure 6. Aeration systems.

Rock-plant filter or vegetative submerged-bed (VSB). Rock-plant filters, also called constructed wetlands, treat septic tank effluent by horizontal flow through a lined bed of gravel (see Figure 7). Roots of adapted wetland plants fill in spaces between rocks. The liner may be plastic, compacted clay, or concrete. These systems can be rewarding for people with a strong interest in gardening and managing their wastewater. The soil dispersal field can be traditional laterals, as shown in Figure 2, or a second unlined wetland cell. Surface discharge is prohibited.

A healthy stand of wetland plants contributes to wastewater treatment, especially nutrient removal. During the growing season, plants take up water and nutrients. However, bacteria growing on rocks and roots accomplish much of the treatment. Thus, treatment continues when plants are dormant. Maintenance is important to keep plant growth vigorous and to prevent clogging the rock bed.

To keep a rock-plant filter from becoming a weed patch, "gardening" is required. This includes replacing or removing dead plants, unwanted species, and trees. Plants with dense fibrous roots may need thinning to maintain wastewater flow through the filter. This gardening is in sewage, so protective clothing and gloves should be worn. The water-level control device should be adjusted as needed to maintain an optimum water level. During high evaporation or low inflow, extra water may need to be added to keep the roots wet and the plants healthy.

Special Systems

Where water is limited — or for other reasons — holding tanks, privies, composting toilets, and incinerating toilets may be used for toilet waste. Graywater (household wastewater, excluding toilet waste) also requires an adequate treatment and dispersal system.

Graywater, sometimes mistakenly thought to be safe to discharge, is high in organic material, fecal bacteria, and nutrients. Wastewater from sources other than toilets (including laundry, bath, shower, and kitchen), called graywater, may contain pathogens, and thus is sewage that must be treated. State standards prohibit the surface discharge of all sewage, whether treated or untreated. Graywater like blackwater (toilet waste) must be discharged to an appropriate traditional or alternative treatment system.

Holding tanks collect sewage discharges in a tank with no outlet that is later pumped and transported to a treatment plant. For a residence on a small lot with no suit-

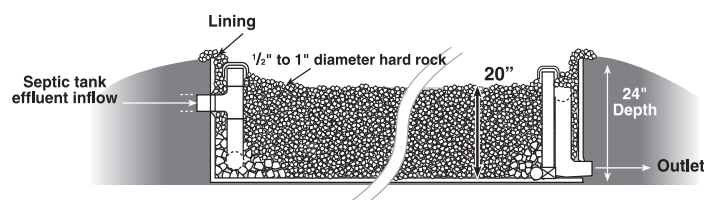

Figure 7. Rock-plant filter.

able soil treatment area available, a holding tank may be practical. It may be acceptable for short-term, intermittent use such as a recreation cabin. But the high cost of hauling sewage makes a holding tank impractical for a long-term, full-time residence. The waste load and cost can be reduced by water conservation.

Low water use systems. In situations with no running water, such as a weekend cabin, non-water carriage or “waterless” toilets (vault privies, composting toilets, incinerating toilets, etc.) may be practical. If water is available, there will be wastewater from sources other than toilets, and a treatment system is required.

Vault toilets (or privies) have risers (seats) over a watertight tank or vault. The bottom of the vault tank should be at least 4 feet above permanent or seasonal water tables. To reduce odors and insects, good ventilation is necessary. Providing a 12-inch diameter black vent pipe from the vault up the south side of the privy will help control odor. For temporary use, portable commercial units can be rented. (See KDHE bulletin on privies.)

Composting toilets. In addition to homemade units, several commercial composting toilets are available. As with privies, the toilet wastes are directly deposited in a holding compartment without flushing. Composting toilets are designed to encourage microbial decomposition of the toilet wastes, and in some designs, biodegradable kitchen waste. The bacterial action produces heat that helps drive off excess moisture and reduce the waste volume. The residue should always be kept away from humans and from contact with food crops. It may be disposed in the trash, by burying, or land application depending on local regulations.

Incinerating toilets use heat from an electric or fuel source to burn toilet waste to ash. The residue is disposed of as solid waste. A paper bowl liner is used to protect the bowl and reduce cleaning. The liner and waste drop into a holding container. The waste is incinerated after two to four uses. These units require an energy source (an operating cost) and a vent pipe (possibly with an odor control device).

Soil Dispersal System Options

Laterals. The design of the soil-dispersal field can be modified to overcome moderate soil-depth limitations by using shallow laterals (see Figure 8). If a restrictive layer is at 56 inches, the required 48 inches vertical separation distance can be achieved with a shallow, in-ground trench at 8 inches. At-grade systems are similar, but the tank effluent is normally pump-dosed to small diameter, perforated pipe installed in rock (or chambers) over the prepared soil surface. The pipes are covered with rock, then with filter fabric, soil, and grass.

If the loading rate is “not recommended for a traditional soil dispersal system,” other options should be considered. When soil permeability is very slow, lagoons may be an excellent choice. When soil depth is also limited in addi-

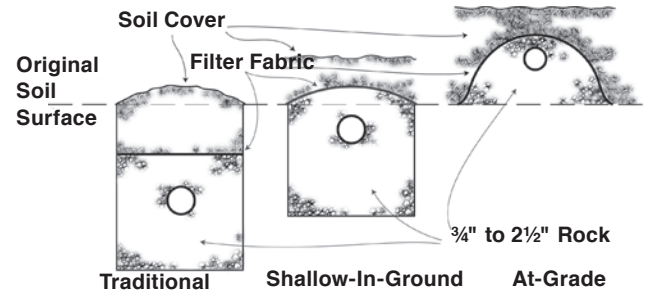

Figure 8. Traditional, shallow-in-ground, and at-grade laterals.

tion to permeability, an alternative system, which provides enhanced pretreatment ahead of dispersal, may be a good choice. For soils that allow very rapid movement of effluent, a timed, pressure-dosing system is a good possibility.

Dispersal bed. A dispersal bed is a wide soil-dispersal system (greater than 5 feet) with at least two distribution pipes (or rows of chambers) not separated by undisturbed soil (see Figure 9). Beds are usually rectangular, with the pipes laid parallel to the long side. Because oxygen movement to the center of a bed is restricted, the biomat is usually thicker and the long-term acceptance rate is lower than for laterals. Thus the bottom area of the bed should be enlarged to 1½ times the bottom area required for lateral trenches. If space is available, laterals are preferred because they are better aerated and have more sidewall area. These factors increase the reserve capacity to handle the wastewater load.

Beds that have little downward seepage into the soil are called evapotranspiration (ET) beds. Before considering an ET bed, a good rule of thumb is that the annual evaporation should exceed the annual precipitation by at least 30 inches (more than 40 inches is better) for the site. Thus, such systems would be suitable only west of U.S. Highway 183 in Kansas.

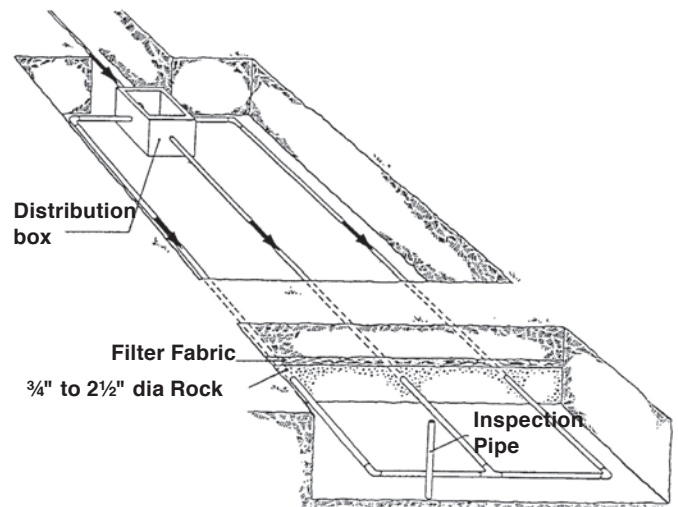

Figure 9. Absorption bed.

Pressure distribution allows effluent to be evenly distributed throughout the dispersal system. By contrast, in a gravity dispersal system the effluent flows into the system, gradually infiltrating as the liquid spreads down the laterals. The inlet ends of the laterals are in constant use and the more distant parts of the trenches are used intermittently.

In pressure distribution, a pump forces effluent through small-diameter pipes – less than 1¼ inch – which have small holes (orifices) spaced along the length. When the pump is activated, the dose is spread evenly over the entire area covered by the pipe network. A timer added to the controls will allow doses to be spaced throughout the day. By alternately dosing and resting the field, the effluent is better aerated and more effectively treated. Thus, the dispersal field usually performs better with a longer life. This same pressure dosing principle is also used in sand filters and mounds.

A *low pressure pipe (LPP)* distribution field, especially on a sloping site, is the most complicated of the dispersal systems to design. The length and diameter of the lateral pipes, the size and spacing of the orifices, the pump capacity, the pressure used for the system, and the

volume and frequency of each dose of wastewater are interrelated. An experienced professional is needed for design and installation.

Regular maintenance on an LPP system includes flushing the lines and checking the pressure by either measuring the height of the water column in a tube or the squirt height at the end of a distribution line when the system is dosing. Perform maintenance on an LPP field at least every 6 months.

Drip dispersal (drip irrigation) is another option that is becoming more common. A drip dispersal system consists of a pump and controls (often with a timer) that distribute treated wastewater through small diameter tubing (typically ½-inch) with specially designed holes (emitters) usually spaced 2 feet apart. Drip dispersal usually requires enhanced treatment, such as ATU or filter system, of septic tank effluent. Although more expensive than other dispersal options, drip dispersal has advantages of shallow placement, dosing, and distribution covering the full area of the field. It also is easily installed in irregularly shaped areas and around obstacles such as trees.

Choosing Systems for Soil and Site Conditions

Tables 1 and 2 summarize the options for wastewater treatment systems appropriate for a variety of soil and site conditions. Table 1 covers ideal, permeable soils of various depths. Table 2 deals with sites that have soil permeability and other limitations.

Table 1. *Choosing an onsite system for permeable¹ soil with depth limits*

Soil Depth to Restriction	Possible Systems
Greater than 6 feet deep	<ul style="list-style-type: none"> • Traditional septic tank and gravity trench dispersal field.
4.75 to 6 feet	<ul style="list-style-type: none"> • Traditional septic tank with shallow in-ground dispersal laterals. • Enhanced treatment system with traditional laterals may be considered.
4 to 4.75 feet	<ul style="list-style-type: none"> • Septic tank with at-grade dispersal laterals where the site is flat or pump-dosed dispersal where the site is sloped. • Enhanced treatment system with traditional laterals may be considered.
1.5 to 4 feet ²	<ul style="list-style-type: none"> • Engineered mound. To avoid surfacing from lateral movement, a mound may not be suitable when an impermeable layer is less than 2 feet deep. • Enhanced treatment system with shallow in-ground drip dispersal. • Pump to a dispersal field in another area that has adequate soil profile.
Less than 1.5 feet ²	<ul style="list-style-type: none"> • Pump to a dispersal field in another area that has adequate soil.

¹ “Permeable soils” for this table are moderately well-drained or well-drained soils ranging from coarse, uncemented sands through more clayey soils with moderate and strong structure. Comparable perc rates are 5 to 60 minutes per inch. Depths are from the surface to a restrictive layer such as clay, shale, groundwater or rock.

² Lagoons also may be considered in these cases. The permeable soil layers and restrictive layers other than high clay soils will require special construction techniques to minimize seepage. A lagoon bottom should be 4 feet above a permanent watertable and a seasonal water table when other suitable options are available.

Cluster Systems for Multiple Homes

Utilizing innovative central sewer system technology, wastewater from a group of homes can easily be collected and handled in one system rather than many individual systems. This usually requires a sewer benefit district that owns and operates the system. Such systems are well suited to fringes of urban areas, rural subdivisions, lake developments, and unsewered towns with small lots. In these cases, space limitations restrict traditional onsite systems.

Significant construction cost savings may be possible by using a cluster system instead of large diameter gravity sewers. However, future maintenance costs are usually greater. Property owners must agree on the organizational and operational details and meet legal requirements before a cluster system can be implemented. Detailed engineering design and specifications are necessary to assure that regulations are met and a long life is assured.

Good Performance and Long Life

Although they are different in appearance and in size, onsite wastewater systems use essentially the same processes that municipal wastewater treatment plants use. However, a very big difference is that trained professionals operate central treatment plants, while the homeowner has responsibility for operating his/her own system. Regular maintenance is required for all systems. However, it is especially important for more complex systems – especially those that use pumps, controls, timers, and pressure distribution.

Keeping good records about the design, location, and past maintenance of onsite systems is important for reference when repairs or maintenance are needed, a problem develops, or property ownership changes.

An accurate sketch of the system makes locating components much easier. Records of tank pumping, system maintenance, and repairs are especially important and

Table 2. *Choosing an onsite system for other site, soil, and owner conditions*

Soil/Site/Owner Conditions	Possible Systems
Slowly or very slowly permeable soils	<ul style="list-style-type: none"> • Lagoon is usually best, especially for slowly permeable soil. • Enhanced treatment system with shallow dispersal, such as drip, with very low loading rates, may be considered.
Highly permeable soils ¹	<ul style="list-style-type: none"> • Time-dosed, low pressure dispersal lateral system. • Enhanced treatment system may be considered for sensitive areas. • Traditional laterals lined with loam soil will slow infiltration and downward movement of percolate, providing better treatment.
Fractured rock ¹	<ul style="list-style-type: none"> • Enhanced treatment with pressure-dosed dispersal may be suitable. • Lagoon with properly constructed lining; usually expensive.
Shallow rock ^{1 2}	<ul style="list-style-type: none"> • Sand filter or rock-plant filter and shallow dispersal laterals.
Small or very small area for onsite system	<ul style="list-style-type: none"> • Enhanced treatment system with a reduced-size dispersal field. • Water conservation measures should be implemented to reduce flow.
Concern about or limit for nitrate in groundwater	<ul style="list-style-type: none"> • Enhanced treatment systems that reduce nitrate (especially those that use recirculation to the septic tank or dosing tank).
Limited or uncertain electric power (frequent outages)	<ul style="list-style-type: none"> • Traditional gravity septic tank and dispersal system or lagoon • Rock-plant filter, when the slope of the site allows for gravity flow. • With enough elevation, a dosing siphon may be used for pressure distribution. However, timed dosing at intervals is not feasible.
Homeowner interest in plants and gardening	<ul style="list-style-type: none"> • Rock-plant filter treatment and dispersal wetland. This may limit resale options. (A lagoon full of cattails and/or duckweed does not qualify.)
Extensive maintenance is unlikely to be done	<ul style="list-style-type: none"> • Home connected to public sewer system. • A contract with a service provider for maintenance must be in force.

¹ Because of rapid movement of percolate through porous soils, adequate treatment is a concern. Thus, soil conditions above the rock must be carefully considered.

² On rocky sites with little topography, rock excavation may be required for placement of the septic tank.

should be transferred to a new owner. Information about local regulations and systems that are allowed and successful in the area is available from local health, building, or zoning departments. Other sources of information are your local K-State Research and Extension office and the National Small Flows Clearinghouse: <http://www.nesc.wvu.edu/wastewater.cfm>, (800) 624-8301 ext. 3 or e-mail info@mail.nesc.wvu.edu and National Onsite Wastewater Recycling Association: <http://www.nowra.org/>, (800)-966-2942.

Additional information is available in the following K-State Research and Extension publications available from the local office or on the Web at www.ksre.ksu.edu:

Aquatic Plants and Their Control, C-667
Assessing Wastewater Options for Small Communities in Kansas, EP at KDHE Web site
Get to Know Your Septic System (Onsite Wastewater Treatment), MF-2179
Land Judging and Homesite Evaluation, S-34
Minimum Standards for Design and Construction of Onsite Wastewater Systems, MF-2214, KDHE Bulletin 4-2, <http://www.kdheks.gov/nps/resources/mf2214.pdf>
Septic Tank Maintenance: A Key to Longer Septic System Life, MF-947
Site and Soil Evaluation for Onsite Wastewater Systems, MF-2645
Wastewater Pond Design and Construction, MF-1044
Wastewater Pond Operation, Maintenance and Repair, MF-2290
Why Do Onsite Wastewater (Septic) Systems Fail? MF-946
Your Wastewater System Owner/Operator Manual, S-90
Environmental Health Handbook, Find at the KDHE website, <http://www.kdheks.gov/nps/lepp/EHH.html>

Original authors of this publication were G. Morgan Powell, Extension water quality engineer (retired) and Barbara L. Dallemand, former Extension onsite wastewater engineer.

Revised by Judith M. Willingham, Extension associate.

Publications are reviewed or revised annually by appropriate faculty to reflect current research and practice.

Date shown is that of publication or last revision.

Brand names appearing in this publication are for product identification purposes only.

No endorsement is intended, nor is criticism implied of similar products not mentioned.

Publications from Kansas State University are available on the World Wide Web at: www.ksre.ksu.edu

Contents of this publication may be freely reproduced for educational purposes. All other rights reserved. In each case, credit Judith M. Willingham, *Selecting an Onsite Wastewater or Septic System*, Kansas State University, July 2010.